

Waterfall Series

wat • er • fall: (noun)

A steep descent of water from a height; a cascade. A comfortable edge shaped like a waterfall.

Provides a more ergonomically-friendly user's edge on the worksurfaces. Use the Waterfall Series where the user's forearm comfort is a concern or the design detail better fits the setting. Choose from two available edges.



Configuration WF6 shown w/optional Open Hutch



"EDGE A" - 90° RADIUS



"EDGE C" - ANGLED COMFORT EDGE

The Maverick Solution

Need specialized pieces with the ergonomically-friendly user's edges?

Call Customer Service for ideas on how to create custom furniture from the Maverick Collection.

Waterfall Series

Designed for ergonomic comfort with choice of two distinctive edge profiles on the user's edge. The clean, contemporary lines of the Waterfall Series chassis combined with the smooth radius of the worksurface edge makes this the perfect choice for all office environments.

Product Specifications

Colors

- 7 standard colors are available on tops and all 16 colors on chassis. See back cover

Tops/Worksurfaces

- 1" TFM (Thermally Fused Melamine) on industrial quality (45 lb.) particleboard
- 1 mm thermally-fused vinyl film postforming with a black reveal line on user's edge plus 2 mm thermally-fused PVC edgebanding on flat edges. Two details available
- Bridge and return tops are shaped to inset to main unit worksurfaces (not modular)
- Single pedestal desk and credenza tops are specially shaped to accept inset of bridge/return (not modular)
- Metal-to-metal connection fittings are installed for bridges and returns
- Wood grain direction on tops of bridges and returns runs from user side to approach side to coordinate with main unit tops



Configuration WF6 shown w/optional Open Hutch and FMP

Chassis Construction

- TFM chassis fastened by screws, steel brackets, and/or concealed fasteners
- ¾ pedestal is standard; full pedestal is optional; double-wall pedestal construction
- 1" thick end panels on desks, returns, credenzas, hutches and bookcases
- ¾ height modesty panels on ¾ pedestal units is standard
- Full height modesty panel on full pedestal units such as lateral file returns is standard
- The modesty inset on the approach side for 30"-deep tops is 6"; for 36"-deep tops inset is 12"
- The modesty panel is flush to the approach edge on 20"-and 24"-deep tops
- Visible edges are edged with 2 mm thermally-fused PVC edge banding
- Adjustable leveling glides are provided on all units that are designed to be set on the floor
- Hutches for Waterfall Series are designed to fit Waterfall Series ONLY
- Product heights are coordinated to facilitate matching, e.g., credenza plus hutch is 65" high. Optional 72" height is available, see page 175
- Standard woodgrain direction on the modesty of pieces 60" wide or less is vertical. On pieces wider than 60", the grain direction is horizontal

Drawer Interiors

- See page 179 for specifications. Black vinyl interior is standard. Optional wood drawer upgrade or maple-color vinyl upgrade is available, see page 176

Drawer Suspension, Construction and Doors

- Black vinyl file and box drawers have full-extension, progressive-action slides with precision steel ball bearings. For optional wood drawers or maple-color vinyl, see page 176
- Heavy-duty file rods in file drawers
- Drawer fronts are inset to end panels except on separate lateral and vertical files
- Recessed finger pulls are provided. Handles are an accessory option, see page 170
- File units only have H3B handles standard
- Overlay drawer fronts are standard on all separate file units. Other furniture with lateral file elements are inset to the end panels of chassis and overlay at the kneespace
- All file and lateral drawers file legal-size from side-to-side
- Each desk is provided with one box drawer convenience tray. See page 172 for optional additional trays for other units
- See filing capabilities on page 179
- File drawer construction accommodates hanging files not stacked material on drawer bottom

Cord Management

- A grommet is standard on computer corner elements and reception units; ¾" clearance at bottom of hutch backs
- Optional wire management is available - grommets on page 171

Locks

- Optional except on vertical and lateral files only; on the personal lateral file, the box drawers do not lock
- Optional locking on all pedestals, hinged-door storage units and hutches is available, see page 171
- Black, removable cores are standard for all locks
- Pedestal key numbers are randomly assigned to all locking pedestals, except that double pedestal units will be keyed alike
- Master keys and keyed-alike combinations are available

Note: Dimensions assigned in this price list are nominal. If exact measurements are required, the requirement must be specified in the order and specifically acknowledged by Maverick Desk. Maverick Desk reserves the right to change construction details and standards without notification, if necessary.

Waterfall Series

How to Order Waterfall Series

WORKSURFACE UNITS: DESKS, CREDENZAS AND RETURNS

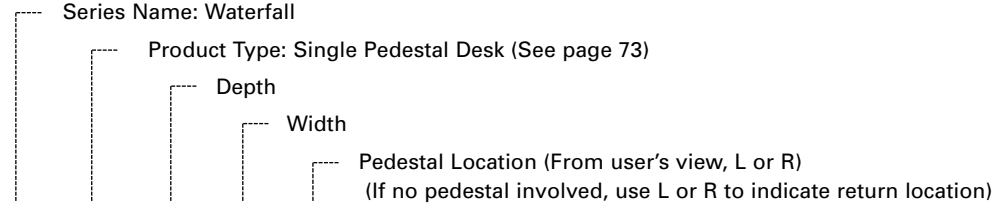

1. Product number: **WF S 36 72 L**
2. Specify Worksurface Finish. See back cover.
3. Specify Worksurface Postform Edge Detail "A" or "C". See below.
4. Specify User or Approach Edge for postform detail. User edge is standard.
5. Specify Worksurface Edge Trim Finish Color. Matching color is standard. See back cover.
6. Specify Chassis Finish. Matching color edge banding is standard. See back cover.
7. Specify Handle Upgrade Options. H3B handle is standard on lateral and vertical file units only. See below and page 170.
8. Specify Accessories or Upgrades. See below and pages 170-177.

HANDLE OPTIONS:

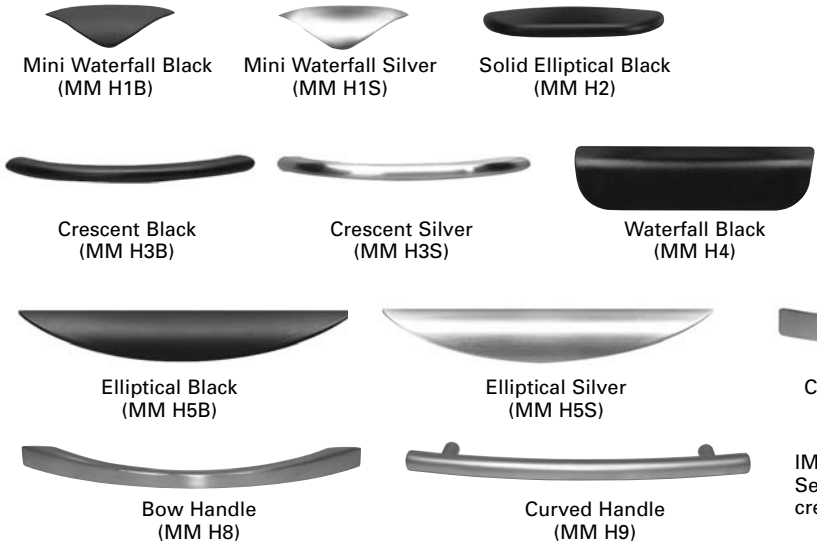

EDGE DETAILS: SIDE VIEW:

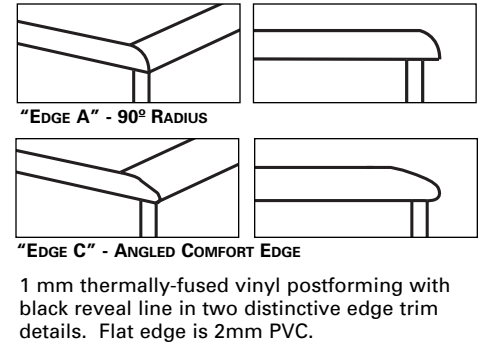

IMPORTANT NOTE: H3B handle is standard only on Waterfall Series storage units and lateral files (except sliding door credenzas). See page 170 for prices. H3, H5 thru H9 are \$20.

OTHER OPTIONS/UPGRADES:

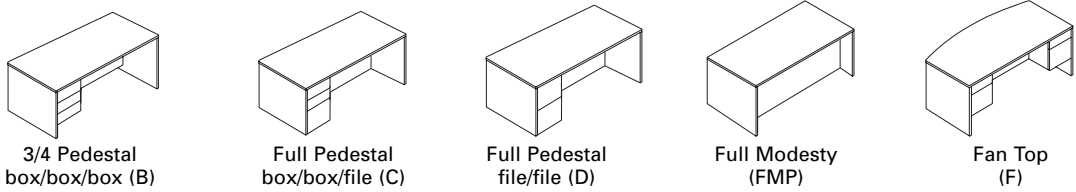

GROMMETS (WORKSURFACE)

Note: While sitting at unit, grommet locations named from left to right. For grommet location on modesty panel add "M" after location. No grommets will be placed over a pedestal. On double pedestal units, grommets will be placed in the kneespace only

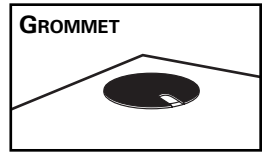
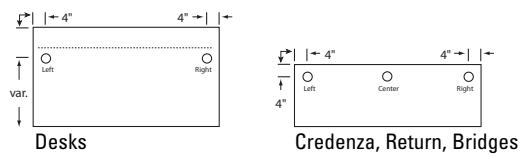

Black grommet is standard. Upgrade to silver color, p. 175

Waterfall Series

Statement of Line

DESKS:

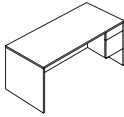

Single
(S)

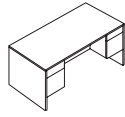

Double
(D)

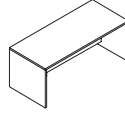

No Pedestal
(N)

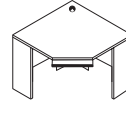

CompuCorner Unit
(CCU)

BRIDGE:

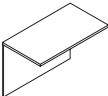

Bridge
(BR)

RETURNS:

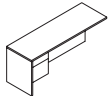

Return - 3/4 ped.
(RA)

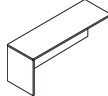

Return - shell
(RN)

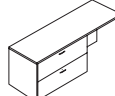

Return - lateral file
(RLF)

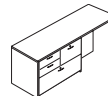

Return - Pers. Lat. File
(RPLF)

CREDENZAS:

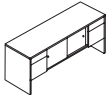

Credenza - dbl. ped. & storage
(C_...2)

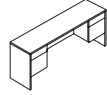

Credenza - dbl. ped.
(C_...3)

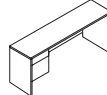

Credenza - sgl. ped.
(C_...4)

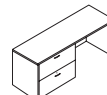

Credenza - lat. file
(C_...5)

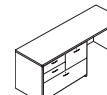

Credenza - pers. lat. file
(C_...6)

HUTCHES:

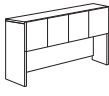

Hutch - with doors
(H_...WD)

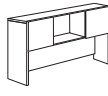

Hutch - inside shelf
(H_...W2D)



Hutch - no doors
(H_...ND)



Hutch - bookcase
(BCH)

FILING:

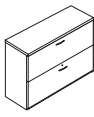

Lateral File
(LF2)



Lateral File - 3-drawer
(LF3)

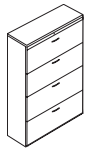

Lateral File - 4-drawer
(LF4)

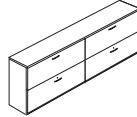

Lateral File - double
(LF_...2+2)

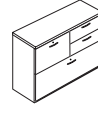

Lateral File - personal
(PLF)



Vertical File
(VF2)

Call Customer Service for customized uses of the ergonomically-friendly edges to meet your needs - 800.414.1655.

Waterfall Series

Configurations

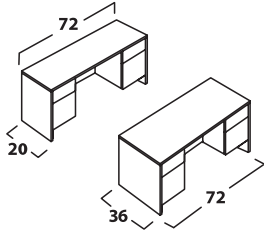

WF1

1 WFD3672	\$1,005
1 WFC2072 3	\$860
	\$1,865

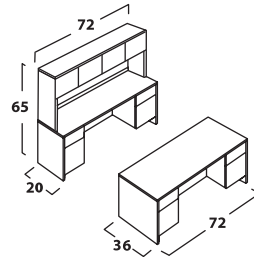

WF2

1 WFD3672	\$1,005
1 WFC2072 3	\$860
1 WFH72WD	\$890
	\$2,755

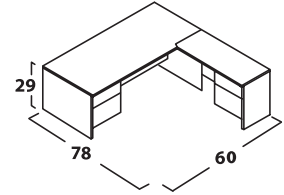

WF3R

1 WFS3060L	\$680
1 WFRA2048R	\$565
	\$1,245

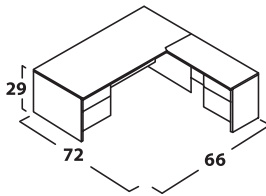

WF4R

1 WFS3066L	\$770
1 WFRA2442R	\$565
	\$1,335

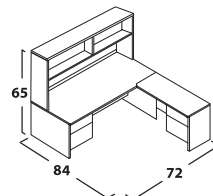

WF5R

1 WFS3672L	\$810
1 WFRA2448R	\$605
1 WFH72ND	\$700
	\$2,115

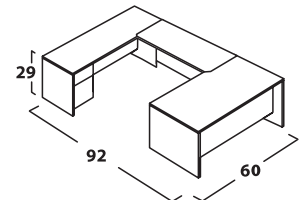

WF6L

1 WFS3060R	\$680
1 WFBR2442	\$390
1 WFC2060 4L	\$605
	\$1,675

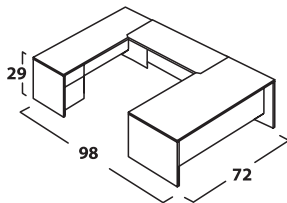

WF7L

1 WFS3672R	\$810
1 WFBR2442	\$390
1 WFC2072 4L	\$690
	\$1,890

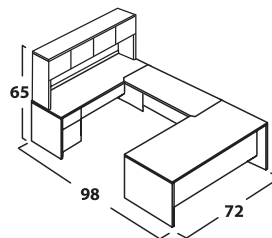

WF8L

1 WFS3672R	\$810
1 WFBR2442	\$390
1 WFC2072 4L	\$690
1 WFH72WD	\$890
	\$2,780

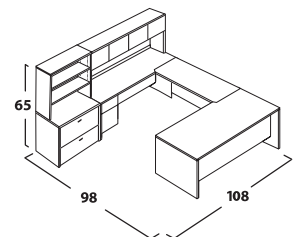

WF9L

1 WFS3672R	\$810
1 WFBR2442	\$390
1 WFC2072 4L	\$690
1 WFH72WD	\$890
1 WFLF202	\$645
1 WFBCH	\$345
	\$3,770

Waterfall Series

Desks

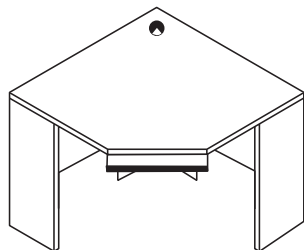
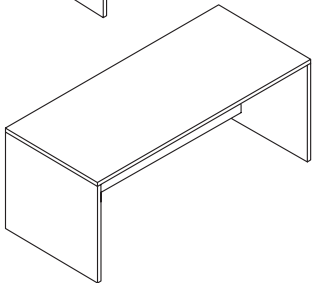
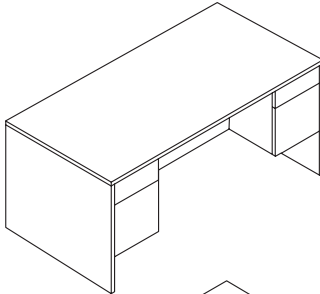
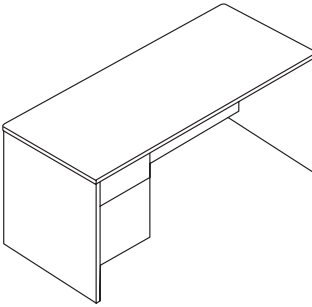
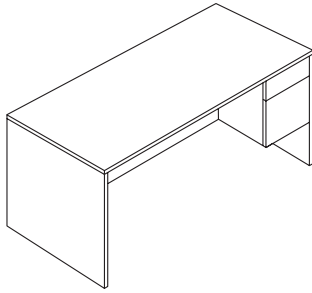

Single Pedestal Desk, Box/File Pedestal, Right (Specify if standalone)

Model#	Depth	Width	Height	Weight	Cube	Price
WFS3048R	30"	48"	29"	142	25	\$625
WFS3060R	30"	60"	29"	190	32	\$680
WFS3066R	30"	66"	29"	202	35	\$770
WFS3072R	30"	72"	29"	214	38	\$800
WFS3672R	36"	72"	29"	225	45	\$810

Optional pedestal lock, p. 171

Single Pedestal Desk, Box/File Pedestal, Left (Specify if standalone)

Model#	Depth	Width	Height	Weight	Cube	Price
WFS3048L	30"	48"	29"	142	25	\$625
WFS3060L	30"	60"	29"	190	32	\$680
WFS3066L	30"	66"	29"	202	35	\$770
WFS3072L	30"	72"	29"	214	38	\$800
WFS3672L	36"	72"	29"	225	45	\$810

Optional pedestal lock, p. 171

Double Pedestal Desk, Box/File Pedestals, Left and Right

Model#	Depth	Width	Height	Weight	Cube	Price
WFD3060	30"	60"	29"	260	32	\$790
WFD3072	30"	72"	29"	270	38	\$990
WFD3672	36"	72"	29"	276	45	\$1,005

Optional pedestal lock, one for each pedestal, p. 171

No-Pedestal Desk and Workstation Tables (3/4 modesty)

Model#	Depth	Width	Height	Weight	Cube	Price
WFN2042	20"	42"	29"	80	15	\$345
WFN2060	20"	60"	29"	92	20	\$410
WFN2072	20"	72"	29"	100	24	\$555
WFN2442	24"	42"	29"	95	18	\$390
WFN2460	24"	60"	29"	120	25	\$480
WFN2472	24"	72"	29"	132	30	\$565
WFN3042	30"	42"	29"	114	22	\$460
WFN3060	30"	60"	29"	126	32	\$535
WFN3072	30"	72"	29"	138	38	\$565
WFN3672	36"	72"	29"	152	45	\$605

Mobile pedestals, see p. 33

Computer Corner Unit, Component (3/4 modesty)

Model#	Depth	Width	Return	Height	Weight	Cube	Price
*WFCCU363620	36"	36"	20"	29"	165	23	\$565
*WFCCU363624	36"	36"	24"	29"	180	23	\$565
WFCCU424220	42"	42"	20"	29"	180	31	\$690
WFCCU424224	42"	42"	24"	29"	180	31	\$690
WFCCU484824	48"	48"	24"	29"	195	40	\$745
WFCCU484830	48"	48"	30"	29"	195	40	\$745

Keyboard tray and worksurface black grommet are standard. *Keyboard tray on 36" units is shipped uninstalled to be added after returns are attached.

See available accessories, pp. 170-174, and upgrades, pp. 175-177.

Waterfall Series

Bridges, Returns

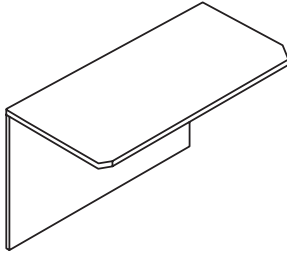

Bridge Section, Component (³/₄ modesty, flush height)

Model#	Depth	Width	Height	Weight	Cube	Price
WFBR2042	20"	42"	19"	48	10	\$335
WFBR2048	20"	48"	19"	48	10	\$345
WFBR2442	24"	42"	19"	55	12	\$390
WFBR2448	24"	48"	19"	63	14	\$410

Worksurface is designed to inset into main unit and back unit.

Returns

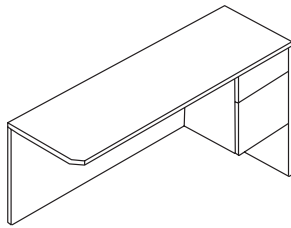

Return, ³/₄ Box/File Pedestal , Right (Flush height)

Model#	Depth	Width	Height	Weight	Cube	Price
WFRA2042R	20"	42"	29"	104	15	\$525
WFRA2048R	20"	48"	29"	107	16	\$565
WFRA2054R	20"	54"	29"	110	17	\$615
WFRA2442R	24"	42"	29"	107	16	\$565
WFRA2448R	24"	48"	29"	107	18	\$605
WFRA2454R	24"	54"	29"	114	20	\$625
WFRA3048R	30"	48"	29"	127	25	\$635

Worksurface insets into main unit. Optional pedestal lock, p. 171.

Return, ³/₄ Box/File Pedestal , Left (Flush height)

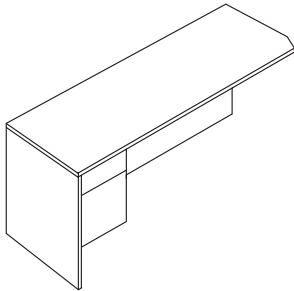

Model#	Depth	Width	Height	Weight	Cube	Price
WFRA2042L	20"	42"	29"	104	15	\$525
WFRA2048L	20"	48"	29"	107	16	\$565
WFRA2054L	20"	54"	29"	110	17	\$615
WFRA2442L	24"	42"	29"	107	16	\$565
WFRA2448L	24"	48"	29"	107	18	\$605
WFRA2454L	24"	54"	29"	114	20	\$625
WFRA3048L	30"	48"	29"	127	25	\$635

Worksurface insets into main unit. Optional pedestal lock, p. 171.

Return Shell, Right (Flush height)

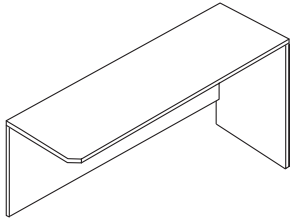

Model#	Depth	Width	Height	Weight	Cube	Price
WFRN2042R	20"	42"	29"	67	15	\$345
WFRN2054R	20"	54"	29"	73	17	\$390
WFRN2442R	24"	42"	29"	67	18	\$400
WFRN2454R	24"	54"	29"	74	20	\$445
WFRN3048R	30"	48"	29"	89	25	\$470

Worksurface insets into main unit. For mobile pedestals, see p. 33.

Return Shell, Left (Flush height)

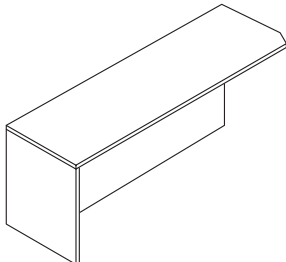

Model#	Depth	Width	Height	Weight	Cube	Price
WFRN2042L	20"	42"	29"	67	15	\$345
WFRN2054L	20"	54"	29"	73	17	\$390
WFRN2442L	24"	42"	29"	67	18	\$400
WFRN2454L	24"	54"	29"	74	20	\$445
WFRN3048L	30"	48"	29"	89	25	\$470

Worksurface insets into main unit. For mobile pedestals, see p. 33.

Waterfall Series

Returns, Credenzas

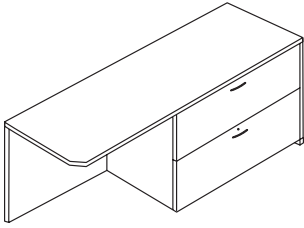

Return, 32" Lateral File, Right (H3B handles, lock, full modesty)

Model#	Depth	Width	Height	Weight	Cube	Price
WFRLF2454R	24"	54"	29"	201	23	\$1,015
WFRLF2460R	24"	60"	29"	208	25	\$1,115
WFRLF2472R	24"	72"	29"	219	30	\$1,220

Worksurface insets into main unit (not modular).

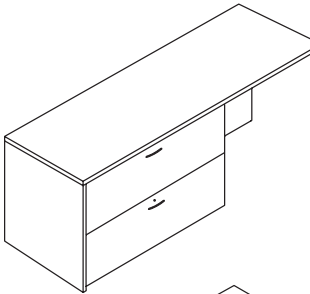

Return, 32" Lateral File, Left (H3B handles, lock, full modesty)

Model#	Depth	Width	Height	Weight	Cube	Price
WFRLF2454L	24"	54"	29"	201	23	\$1,015
WFRLF2460L	24"	60"	29"	208	25	\$1,115
WFRLF2472L	24"	72"	29"	219	30	\$1,220

Worksurface insets into main unit (not modular).

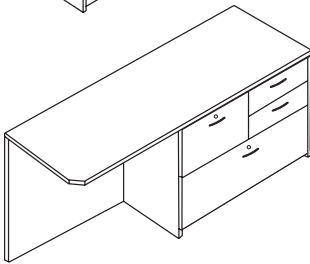

Return, 32" Personal Lateral File, Right (H3B handles, locks, full modesty)

Model#	Depth	Width	Height	Weight	Cube	Price
WFRPLF2454R	24"	54"	29"	205	23	\$1,115
WFRPLF2460R	24"	60"	29"	213	28	\$1,180
WFRPLF2472R	24"	72"	29"	223	30	\$1,335

Box drawers do not lock. Worksurface insets into main unit (not modular).

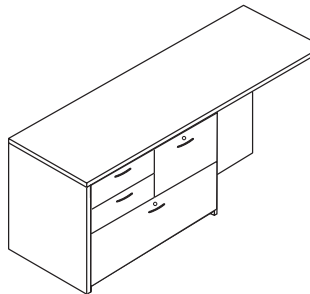

Return, 32" Personal Lateral File, Left (H3B handles, locks, full modesty)

Model#	Depth	Width	Height	Weight	Cube	Price
WFRPLF2454L	24"	54"	29"	205	23	\$1,115
WFRPLF2460L	24"	60"	29"	213	28	\$1,180
WFRPLF2472L	24"	72"	29"	223	30	\$1,335

Box drawers do not lock. Worksurface insets into main unit (not modular).

Credenzas

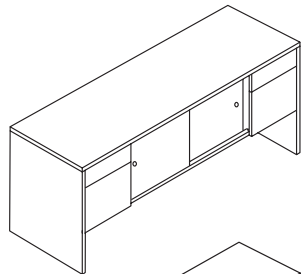

Credenza, Double Pedestal, Box/File Left and Right, Center Storage (Sliding doors)

Model#	Depth	Width	Height	Weight	Cube	Price
WFC2060 2	20"	60"	29"	180	21	\$810
WFC2072 2	20"	72"	29"	240	25	\$925
WFC2472 2	24"	72"	29"	260	29	\$930

Storage includes one adjustable $\frac{1}{4}$ "-thick shelf. May be upgraded to hinged doors, see p. 177. Optional pedestal locks available, one for each pedestal, see p. 171.

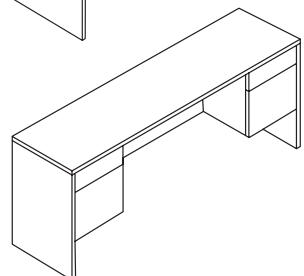

Credenza, Double Pedestal (Knee space)

Model#	Depth	Width	Height	Weight	Cube	Price
WFC2060 3	20"	60"	29"	196	24	\$760
WFC2072 3	20"	72"	29"	215	28	\$860
WFC2472 3	24"	72"	29"	225	29	\$870

Optional pedestal locks available, one for each pedestal, see p. 171.

Waterfall Series

Credenzas

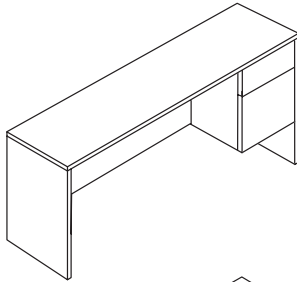

Credenza, Single Box/File Pedestal, Right (Specify if standalone)

Model#	Depth	Width	Height	Weight	Cube	Price
WFC2060 4R	20"	60"	29"	150	21	\$605
WFC2072 4R	20"	72"	29"	164	25	\$690
WFC2472 4R	24"	72"	29"	184	29	\$720

Optional pedestal lock available, see p. 171.

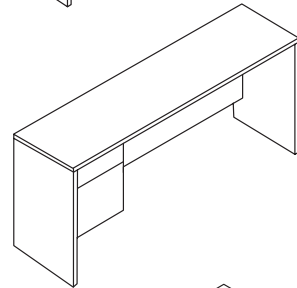

Credenza, Single Box/File Pedestal, Left (Specify if standalone)

Model#	Depth	Width	Height	Weight	Cube	Price
WFC2060 4L	20"	60"	29"	150	21	\$605
WFC2072 4L	20"	72"	29"	164	25	\$690
WFC2472 4L	24"	72"	29"	184	29	\$720

Optional pedestal lock available, see p. 171.

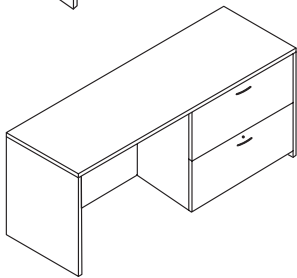

Credenza, 36" Lateral File Pedestal, Right (H3B handles, lock, full modesty)

Model#	Depth	Width	Height	Weight	Cube	Price
WFC2066 5R	20"	66"	29"	223	23	\$1,065
WFC2072 5R	20"	72"	29"	230	25	\$1,090
WFC2472 5R	24"	72"	29"	250	29	\$1,080

Specify if standalone.

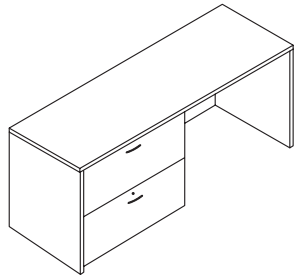

Credenza, 36" Lateral File Pedestal, Left (H3B handles, lock, full modesty)

Model#	Depth	Width	Height	Weight	Cube	Price
WFC2066 5L	20"	66"	29"	223	23	\$1,065
WFC2072 5L	20"	72"	29"	230	25	\$1,090
WFC2472 5L	24"	72"	29"	250	29	\$1,080

Specify if standalone.

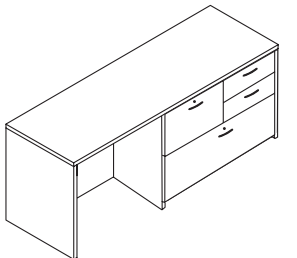

Credenza, 32" Personal Lateral File Pedestal, Right (H3B handles, locks, full modesty)

Model#	Depth	Width	Height	Weight	Cube	Price
WFC2066 6R	20"	66"	29"	230	26	\$1,220
WFC2072 6R	20"	72"	29"	236	25	\$1,260
WFC2472 6R	24"	72"	29"	256	29	\$1,240

Box drawers do not lock. Specify if standalone.

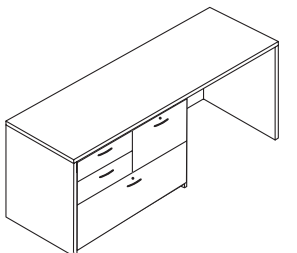

Credenza, 32" Personal Lateral File Pedestal, Left (H3B handles, locks, full modesty)

Model#	Depth	Width	Height	Weight	Cube	Price
WFC2066 6L	20"	66"	29"	230	26	\$1,220
WFC2072 6L	20"	72"	29"	236	25	\$1,260
WFC2472 6L	24"	72"	29"	256	29	\$1,240

Box drawers do not lock. Specify if standalone.

See available accessories, pp. 170-174, and upgrades, pp. 175-177.

Waterfall Series

Hutches

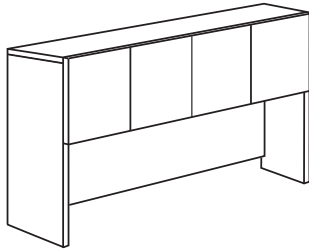

Hutch, with Doors (20" below doors)

Model#	Depth	Width	Height	Weight	Cube	Price
WFH60 WD	14"	60"	36"	155	18	\$760
WFH72 WD	14"	72"	36"	179	21	\$890

Waterfall Series hutch fits Waterfall Series worksurfaces only. Optional locks - two required, see p. 171. May be upgraded to 42" height, see p. 175. Add tasklights, fascia and tackboards, see p. 174.

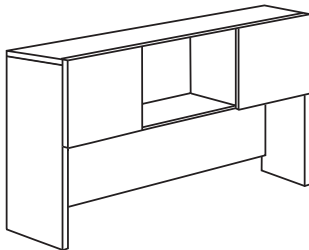

Hutch, Two Doors, Center Opening (20" below doors)

Model#	Depth	Width	Height	Weight	Cube	Price
WFH60 W2D	14"	60"	36"	140	18	\$735
WFH72 W2D	14"	72"	36"	164	21	\$820

Waterfall Series hutch fits Waterfall Series worksurfaces only. Doors are same width as open space. Optional locks - two required. See p. 171. May be upgraded to 42" height, see p. 175. Add tasklights, fascia and tackboards, see p. 174.

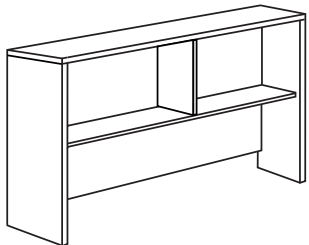

Hutch, No Doors (21" below shelf)

Model#	Depth	Width	Height	Weight	Cube	Price
WFH60 ND	14"	60"	36"	135	18	\$605
WFH72 ND	14"	72"	36"	160	21	\$700

Waterfall Series hutch fits Waterfall Series worksurfaces only. May be upgraded to 42" height, see p. 175. Add tasklights, fascia and tackboards, see p. 174.

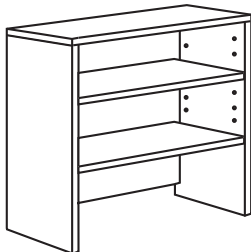

Bookcase Hutch (Two 1"-thick adjustable shelves)

Model#	# Shelves	Depth	Width	Height	Weight	Cube	Price
WFBCH	2	14"	36"	36"	72	11	\$345

Waterfall Series hutch fits Waterfall Series worksurfaces only. May be upgraded to 42" height, see p. 175.

Waterfall Series

Files

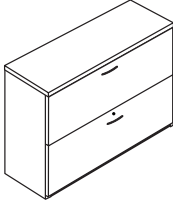

2-drawer Lateral File (H3B handles, lock)

Model#	Depth	Width	Height	Weight	Cube	Price
WFLF202	20"	36"	29"	160	13	\$645
WFLF242	24"	36"	29"	176	15	\$680

Optional anti-tilt lock available, see p. 176

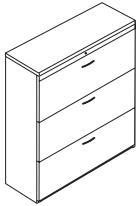

3-drawer Lateral File (H3B handles, anti-tilt lock)

Model#	Depth	Width	Height	Weight	Cube	Price
WFLF203	20"	36"	43"	240	18	\$1,145
WFLF243	24"	36"	43"	264	22	\$1,180

Four-week lead time.

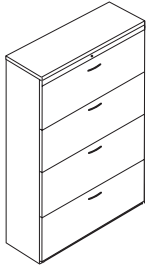

4-drawer Lateral File (H3B handles, anti-tilt lock)

Model#	Depth	Width	Height	Weight	Cube	Price
WFLF204	20"	36"	55"	330	23	\$1,455
WFLF244	24"	36"	55"	335	28	\$1,535

Four-week lead time.

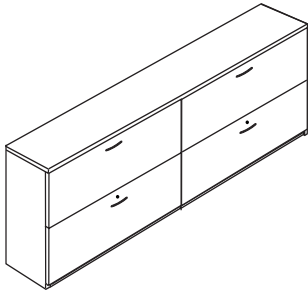

Double Lateral File (H3B handles, locks)

Model#	Depth	Width	Height	Weight	Cube	Price
WFLF202+2	20"	72"	29"	330	25	\$1,335
WFLF242+2	24"	72"	29"	335	30	\$1,380

Optional anti-tilt lock available, two required, see p. 176

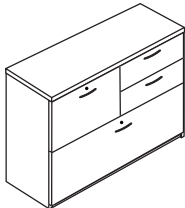

32" Personal Lateral File (H3B handles, locks)

Model#	Depth	Width	Height	Weight	Cube	Price
WFPLF20	20"	31"	29"	189	11	\$780
WFPLF24	24"	31"	29"	205	13	\$810

Box drawers do not lock.

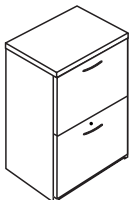

Vertical File (H3B handles, lock)

Model#	Depth	Width	Height	Weight	Cube	Price
WFVF2	24"	16"	29"	160	7	\$565
WFVF2LGL	24"	19"	29"	172	8	\$625

See available accessories, pp. 170-174, and upgrades, pp. 175-177.

Waterfall Series

Waterfall Specific Upgrade

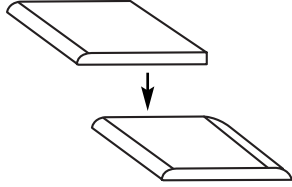

Add Same Edge Detail Postform to Opposite Edge (Approach or Side)

Model#		Price
WF 2A	Add 90° radius edge to opposite side	\$170
WF 2C	Add angled comfort edge to opposite	\$195

Specify edges to be postformed.

Nearly all of the Maverick Series (MM) accessories and upgrades are available on Waterfall. See pages 170-177.

**Need specialized pieces with the ergonomically-friendly user's edges?
Call Customer Service for ideas on how to create custom furniture from the Maverick Collection.**

See available accessories, pp. 170-174, and upgrades, pp. 175-177.